

Pedal Cat

You can pedal or power this water cruising bicycle

Powered with a 3-hp outboard motor, Pedal Cat skims across the water. Speed controls are within easy reach of rider.



By WILLIAM D. JACKSON

Naval Architect

Craft Print Project No. 221

PEDAL CAT is a paddle-wheel driven catamaran which you operate much the same as a bicycle. It will navigate in about $3\frac{1}{2}$ in. of water, is silent, and can be used upon protected waters anywhere. Resort operators will find this water craft a popular addition to a fleet of rentable boats. If you prefer to power it with a small outboard motor, the paddle wheel may be removed and the motor clamped to an engine support board. Simply lock the outboard motor in the dead-ahead position and steer with the handlebar-controlled rudder.

The materials needed to build *Pedal Cat* are exterior fir plywood and pine, fir or hemlock solid stock available at local lumber yards. The paddle-wheel foot cranks, bearings and handle bar are made of ordinary standard pipe and pipe fittings available at local hardware or plumbing stores. Refer to list of materials when purchasing parts.

The pontoons measure almost 10 ft. in length. If 4 x 10 ft. plywood panels are available, well and good; if, however, your lumber dealer stocks only 4 x 8 ft. panels, it's an easy matter to butt

join the pieces with reinforcing lap blocks. To start building, lay out and cut the pontoon sides, top and bottom pieces as shown in Fig. 1 so that the joints in the various parts will not be in line, but staggered as in Fig. 2. For accuracy, lay out and saw the pieces for one side first. Then, temporarily join them together and use as a pattern for making the other three sides. Use the first side to lay out the curved fore and aft lower chine pieces too.

When you have all the pieces for the sides and the upper and lower chines cut, coat the contacting areas with *Elmer's Waterproof*, *Penacolite* 61124 or *Weldwood* glue and fasten chines to each side with either 1-in. *Simba* nails or 1-in. #6 *fh* screws, spaced about 2 in. apart. Be sure to assemble the pontoon sides so you will have one right and one left hand side piece with the chines on the inside. Cut and fit lap blocks where the plywood side pieces join (Fig. 2) and glue and screwfasten in place.

After the glue has dried, clamp the sides together to form two pairs and plane the edges of the $\frac{1}{4}$ -in. plywood sides and chines to make

Operating Pedal Cat by paddle wheel is like riding a bicycle on water.

each pair exactly the same size and shape. Then remove clamps and separate the sides of each pair 18 in., measuring from the outside of the plywood sides, and nail scrap wooden strips across to temporarily hold the sides in position. Square across the ends of the sides and nail some of the strips diagonally so that the sides will not move out of position.

Cut and bevel the fore and aft nose pieces (Fig. 2) and fasten between the sides with two 2-in. #10 fh screws at each joint driven through the sides from the outside. Drill lead holes for the screws first and countersink the screw heads flush.

Lay out and mark the locations of the cross pieces on the lower chins (Fig. 2) and cut and fasten the cross pieces between the chins with two 2-in. #10 fh screws as you did the nose pieces. Saw notches in each cross piece as in Fig. 2 for limber holes. To make the center members (Fig. 2), take the dimensions directly from each pontoon since there may be some slight variation in size. Cut and fit the two pads for each pontoon and carefully measure the depth to make the notches in the center sections because the pads must be flush with the top of the upper chins. Assemble the three pieces with 2-in. #8 fh screws to the inside of each pontoon as in Figs. 2 and 5.

The bottom plywood is applied first. If 4 x 8-ft. plywood is being used, butt join the two pieces at the center cross piece (Fig. 2). Coat all contacting surfaces with Kuhls Ario glue, lay canton flannel strips on glued area, recoat, and fasten plywood to the chins, nose and cross pieces with 1-in. #6 fh screws spaced 2 in. apart. Finish by trimming the plywood flush with the fore and aft nose pieces. To prevent damage to the paddle wheel both in and out of the water, make and screwfasten the skids (Fig. 2).

Because the inside of the pontoons

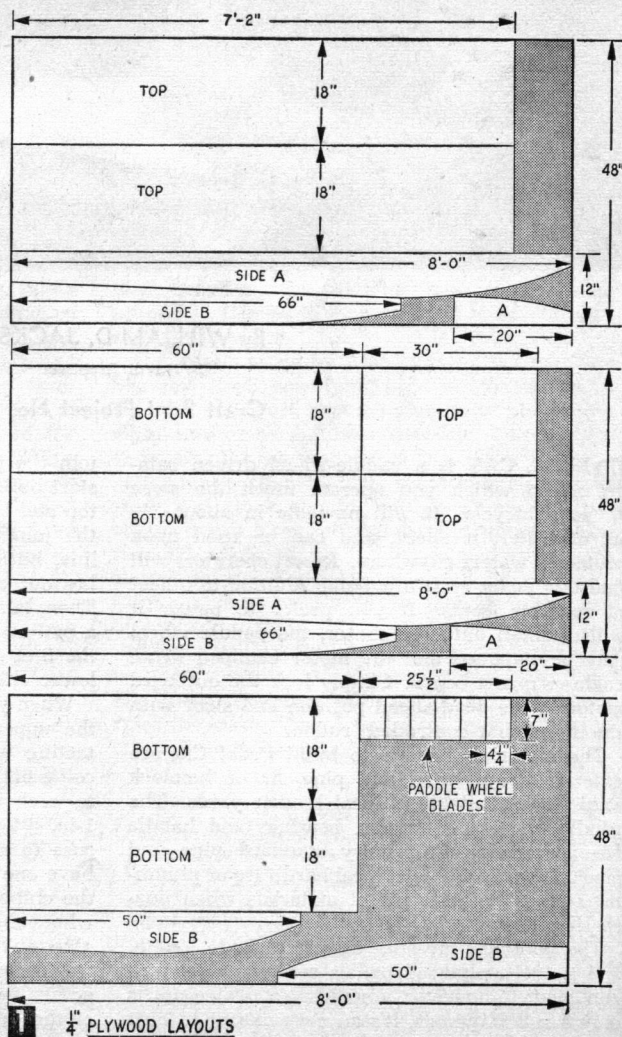

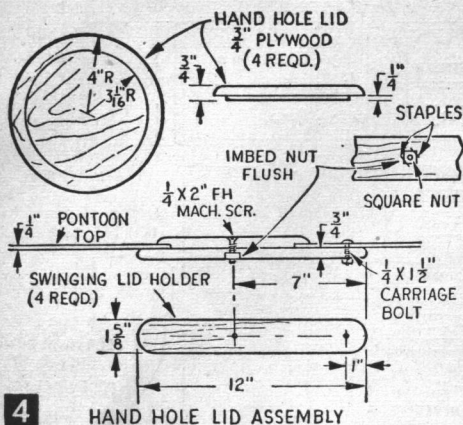

4

HAND HOLE LID ASSEMBLY

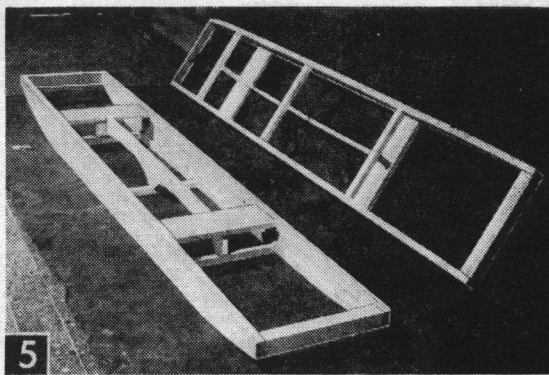

Pontoon frames before covering top and bottom with 1/4-in. plywood.

MATERIALS LIST—PEDAL CAT

Lumber:

No.	Description	Use
2	1 5/8 x 4 1/2 x 45"	pontoon cross members
1	3/4 x 1 1/2 x 12'	chines and carlins
1	3/4 x 7 1/2 x 10'	center members
1	1/4 x 5 x 60"	pontoon cross pieces
1	3/4 x 5 1/2 x 72"	pontoon pads
1	1 7/8 x 1 3/8 x 16"	saddle support bars
1	1 7/8 x 6 x 14"	saddle supports
1	1 7/8 x 1 1/2 x 24"	motor board and brackets
1	1 7/8 x 6 x 48"	nose pieces
12	1/2 x 1 x 12 1/2"	paddle-wheel spokes
2	1 7/8 x 1 3/8 x 50"	ledge pieces
4	3/4 x 1 3/8 x 12"	swinging lid holders
1	1 7/8 x 1 1/2 x 72"	wheel house uprights
2	3/4 x 1 3/8 x 10"	rub rails

Plywood: Fir Exterior AA or AB Grade

1	3/8" x 4' x 6'
3	1/4" x 4' x 8'
1	3/4 x 24 x 48"
1	1/8 x 9 x 60"

Fastenings:

5 gross	1" #6 fh screws
3 doz.	1 1/4" #8 fh screws
3 doz.	3/4" #6 rh screws
2 doz.	2" #8 fh screws
4 doz.	2" #10 fh screws
8	1 1/2" #12 fh screws
1 lb.	2" Simba nails
1	1/4" x 2" eye bolt

Sheet Metal:

1 pc.	31" galv. sheet metal or aluminum
-------	-----------------------------------

Pipe Fittings (Galvanized):

4	3/8" pipe floor flanges
4	90° elbows (3/8" pipe)
2	3/8" pipe caps
2	3/8" pipe nipples 4 1/2" long
4	3/8" pipe nipples 4" long
2	3/8" pipe lock nuts
2	3/8" iron washers—spacers
1 pc.	3/8" pipe 12" long
1 pc.	3/8" pipe 36" long
2 pcs.	3/8" pipe 12" long
1	3/8" pipe tee
2	3/8" pipe 45° elbows
2	3/8" pipe nipples 2" long
2	3/8" to 1/2" pipe bushing

Bolts (Galvanized):

16	1/4 x 1" rh stove bolts
6	1/4 x 3" carriage bolts
4	1/4 x 4 1/2" carriage bolts
1	5/16 x 5 1/2" carriage bolt
1	1/4 x 4" carriage bolt
4	1/4 x 2" fh mach. bolts
4	1/4 x 1 1/2" carriage bolts
1 pair	bicycle foot pedals

Miscellaneous: 2 quarts Kuhls Bedlast

wheel housing, paddle-wheel discs
pontoon, paddle blades
lids, saddle, sheet-metal formers
wheel housing top

planking

ledge to wheel housing
sheet metal to fore end housing
pads pontoon tops
ledge pcs. to pontoons, nose pcs.
motor board
(Herter's Inc., Waseca, Minn.)
for mooring

wheel housing

paddle wheel cranks
paddle wheel cranks
paddle wheel cranks
paddle wheel cranks
paddle wheel cranks
paddle wheel cranks
paddle wheel separators—inside
case—(see drawing)
rudder shaft and handle bars
rudder shaft and handle bars
rudder shaft and handle bars
rudder shaft and handle bars
rudder shaft bearings

flanges

aft cross piece
fore cross piece
saddle
saddle
lids
swinging arms, lids

corners slightly and give the pontoons two coats of flat *Boatlife* followed with one coat of high gloss of the desired color.

To make the wheel housing, lay out and saw two sides and two paddle wheel discs as shown in Fig. 3. Cut two upright pieces (Fig. 6), rabbet 3/8 x 3/4 in. and fasten to wheel-house sides with glue and 1 1/4-in. #8 fh screws spaced 4 in. apart. Now, using the curved edge of the sides, lay out and cut the two 3/4 x 1 1/4-in. curved carlins. Glue and fasten the carlins to the inside of the housing sides with 1-in. #6 fh screws spaced 2 in. apart.

To support the housing on the pontoons, glue and fasten the 1 3/8-in. square ledge pieces (Fig. 6) 1 3/4 in. from the bottom edge and on the outside of the housing sides. Use 1/4-in. #8 fh screws driven through the 3/8-in. sides from the inside. Holes for screws fastening the ledges to the pontoons can be drilled now or before the ledge pieces are fastened to the sides. Drill for eight 2-in. #10 fh screws in each ledge piece and countersink on top side.

Now set the two housing side pieces aside and make the spacer, two saddle-supported bars and two formers (Fig. 6). Then assemble the sides with the spacer bars and formers using two 2-in. #10 fh screws driven through the sides from the outside (Fig. 7). Two small 3/4 x 4-in. blocks will be needed between the lower formers and sides as shown in Fig. 6.

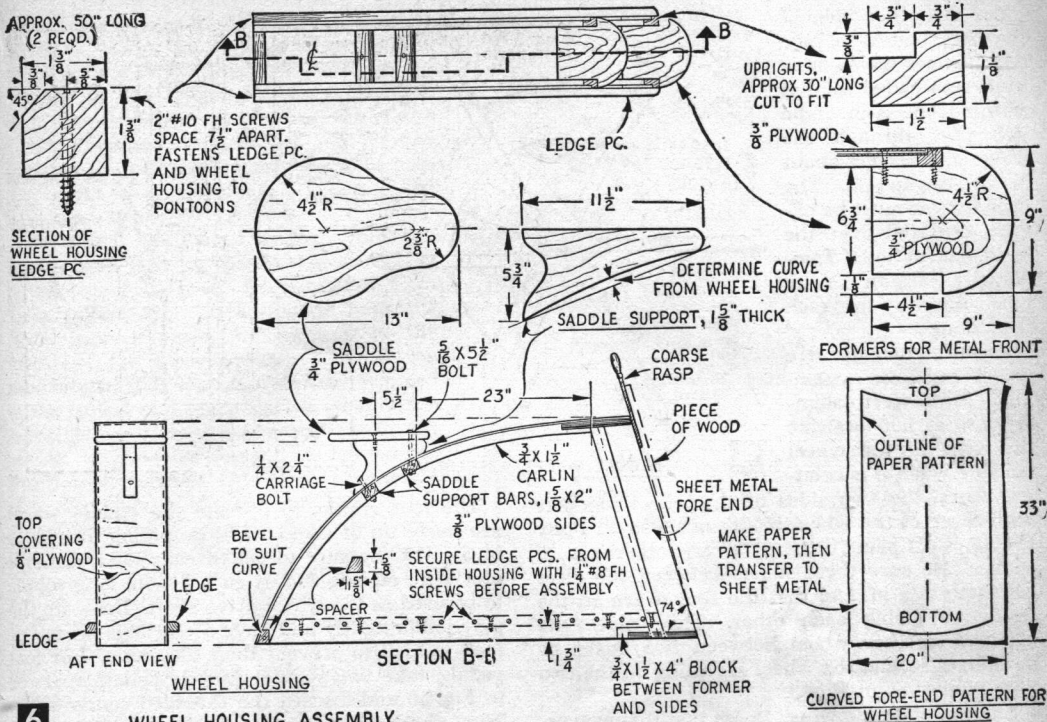

6 WHEEL HOUSING ASSEMBLY

With a coarse rasp and using about a 40-in. strip of $\frac{3}{4} \times 1\frac{1}{2}$ -in. wood as a guide (Fig. 6), bevel the curved edges of the formers to take the sheet metal front. To determine the exact size and shape to cut the sheet metal, use heavy paper wrapped around the housing front to make a paper pattern. After cutting the sheet metal to size, have your local sheet-metal shop form the metal in a rolling machine. Fasten the metal to the front of the wheel housing with *Bedlast* on

all contacting surfaces and secure with $\frac{3}{4}$ -in. #6 rh screws spaced about 3 in. apart. Also fasten the $\frac{1}{8}$ -in. plywood over the curved part of the wheel housing with *Bedlast* and $\frac{3}{4}$ -in. #6 fh screws spaced about 2 in. apart. Then paint the inside and outside of the wheel housing with three coats of marine paint.

Make the rider's seat or saddle of $\frac{3}{4}$ -in. plywood and bolt it to the housing through the two saddle supports (Fig. 6). Cut the fore and aft pontoon cross members (Fig. 2) and drill the $\frac{5}{16}$ -in. bolt holes as dimensioned so that these pieces will be ready for assembly. If you intend to use an outboard motor with your version of Pedal Cat, make up the three pieces necessary for the motor board (Fig. 8) and screwfasten to the aft pontoon cross member.

The paddle wheel is the next item upon the agenda. Make twelve $\frac{1}{2} \times 1 \times 1\frac{1}{2}$ -in. spokes and six wheel blades (Fig. 9). Drill and countersink for screws as shown. Lay out the previously cut wheel discs in 60° segments as in Fig. 9 and drill a $\frac{3}{4}$ -in. hole through the exact center of both discs. Then fasten the spokes to the discs with two 1-in. #6 fh screws through each spoke.

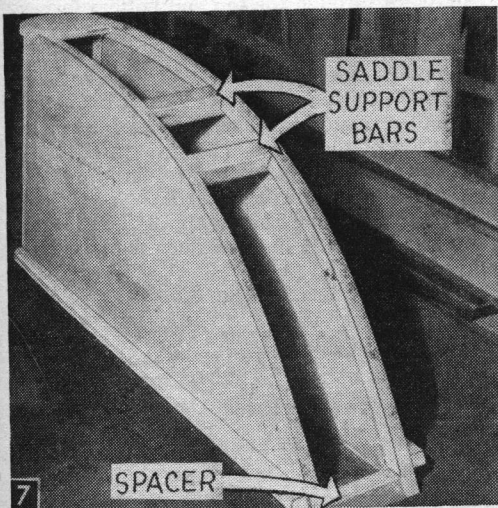

7 Paddle-wheel housing showing saddle support bars and aft spacer.

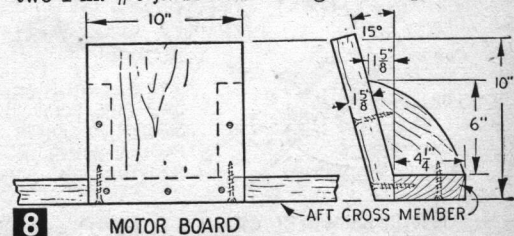

8 MOTOR BOARD

On the other side of the discs, bolt $\frac{3}{8}$ -in. pipe floor flanges which have been rethreaded so that a threaded $\frac{3}{8}$ -in. pipe will pass through the flange and project about $\frac{3}{4}$ in. beyond it. The floor flanges must be exactly centered over the $\frac{3}{4}$ -in. drilled holes. Temporarily fasten $\frac{3}{8}$ -in. pipe nipples in each floor flange.

Because the paddle wheel must be assembled in perfect alignment so as not to strike the sides of the wheel housing when it is rotated, clamp the two sides of the wheel together with three of the wheel blades using small Pony C-clamps. Space them at every other set of spokes. Be sure the distance between the discs is exactly $5\frac{1}{8}$ in. and that the spokes are on the inside or facing each other. Then place the clamped-together wheel between two boxes or sawhorses so that the wheel is resting on the two pipe nipples as in Fig. 9.

Slowly rotate the wheel to see that it runs true. If necessary loosen the clamps and readjust the blades or wheel sides to make it run true. When you are satisfied that the wheel sides are in alignment, clamp and screw-fasten the other three blades to the remaining spokes. Drill pilot holes in the spokes for the screws to prevent splitting. Then screwfasten the first three blades to the spokes. Finish the wheel by applying three coats of paint.

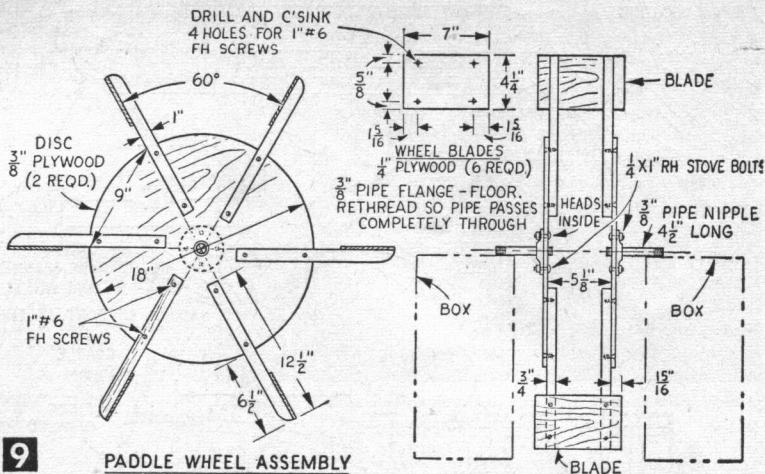

9

PADDLE WHEEL ASSEMBLY

The foot cranks to operate the paddle wheel are made up of standard $\frac{3}{8}$ -in. piping fittings as in Fig. 10. Be sure to cut threads for a distance of $1\frac{1}{4}$ in. on one end of each $4\frac{1}{2}$ -in. long nipple to be used as the wheel drive shaft. Draw up the pipe joints tightly and have the fittings brazed or tack welded to prevent their loosening. For foot pedals, take two regular bicycle pedals apart as in Fig. 10 and discard the threaded center shaft. Then check to see if the bearings are large enough to go over a $\frac{3}{8}$ -in. pipe. If not, remove the bearings and ream out the hole to $\frac{5}{8}$ -in. dia. so that you can slide the pedals on the $\frac{3}{8}$ -in. pipe cranks. Use pipe caps to keep the pedals in place.

Before placing the wheel in the wheel housing, make up the handle bars of $\frac{3}{8}$ -in. pipe and the rudder and ruddershaft as in Fig. 12. For the shaft bearing, use two $\frac{3}{8}$ to $\frac{1}{2}$ -in. pipe bushings and have the inside threads reamed or bored out for a loose fit with the $\frac{3}{8}$ -in. pipe shaft. Drill $\frac{1}{16}$ -in. holes through the top and bottom formers of the wheel housing at a 16° angle as in Fig. 12 and turn the bushings in place as you would a self-tapping screw. Place the rudder shaft through the bushings to make sure it turns freely, and then remove it to facilitate working on the installation of the wheel.

To assemble the paddle wheel in the wheel housing, first locate and drill $\frac{1}{16}$ -in. holes through the housing sides (Fig. 3). The wheel bearings are two $\frac{3}{8}$ -in. pipe floor flanges. Have

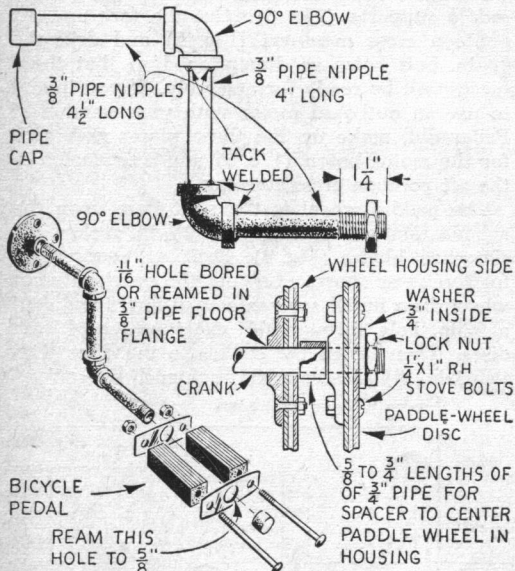

PADDLE-WHEEL CRANKS (2 REQD.)

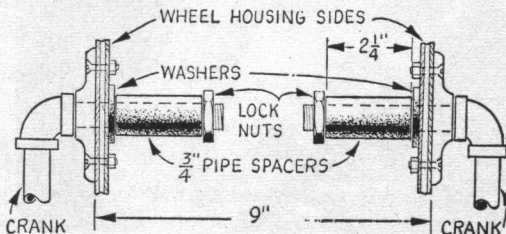

CRANK ARRANGEMENT WHEN MOTOR IS USED INSTEAD OF PADDLE WHEEL

10

11

the threaded holes in the flanges reamed or bored to $1\frac{1}{16}$ -in. dia. at your local machine or plumbing shop. Then bolt them to the outside of the housing exactly centered over the $1\frac{1}{16}$ -in. drilled holes. Insert the $1\frac{1}{4}$ -in. threaded ends of the foot cranks through the bearings so that the ends project about $\frac{5}{8}$ in. beyond the inside of the housing walls.

To center the wheel and prevent the blades from striking the sides of the wheel house, cut two $\frac{5}{8}$ -in. long spacers from $\frac{3}{4}$ -in. pipe (Fig. 10) and slide over the $\frac{3}{4}$ -in. nipples projecting through to the inside of the wheel house. Remove the pipe nipples that were temporarily fastened to the wheel and place the wheel into the wheel house. Then locate and fasten the cranks to the pipe flanges on the wheel. Position the cranks 180° apart or exactly opposite, as on a bicycle, and lock to the wheel discs by placing large washers and pipe lock nuts on the ends of the nipples (Fig. 10). Turn the wheel with the foot cranks to see that it rotates freely and clears the housing sides. The paddle wheel should be removed when an outboard motor is used. Foot pedals and cranks can be reinserted through the wheel-house sides and fastened in place by sliding two $\frac{3}{4}$ -in. pipe spacers over the crank arms before fastening them in place with lock nuts (Fig. 11).

The next step is that of fitting the wheel housing to the pontoons. Place both pontoons on sawhorses or wooden blocks 9 in. apart and line up the ends perfectly. Measure and mark the 35-in.

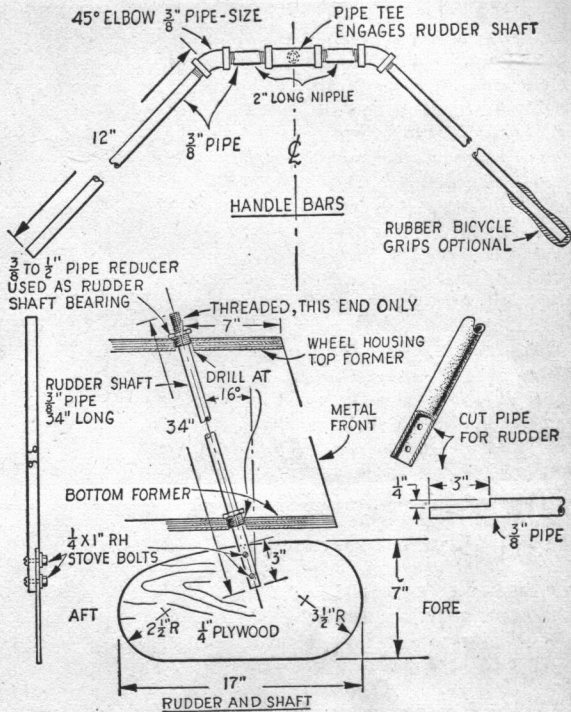

12

RUDDER, SHAFT AND HANDLE BAR ASSEMBLY

distance from the aft ends of the pontoons (Fig. 13) and place the wheel housing between the pontoons so it rests on the ledge pieces at the measured mark. It may be necessary to move the pontoons closer or farther apart so that they fit tightly against the housing.

Now, place the aft pontoon cross member with the motor board attached directly in back of the housing and across the pontoons, and bolt to the pontoons (Fig. 13). As the bolt holes are already drilled in the cross member, merely insert a bolt in each hole and tap lightly to mark bolt hole locations on the pontoons. Then remove cross member, drill holes and replace member. When bolting, reach through hand holes in pontoons and place washers and nuts

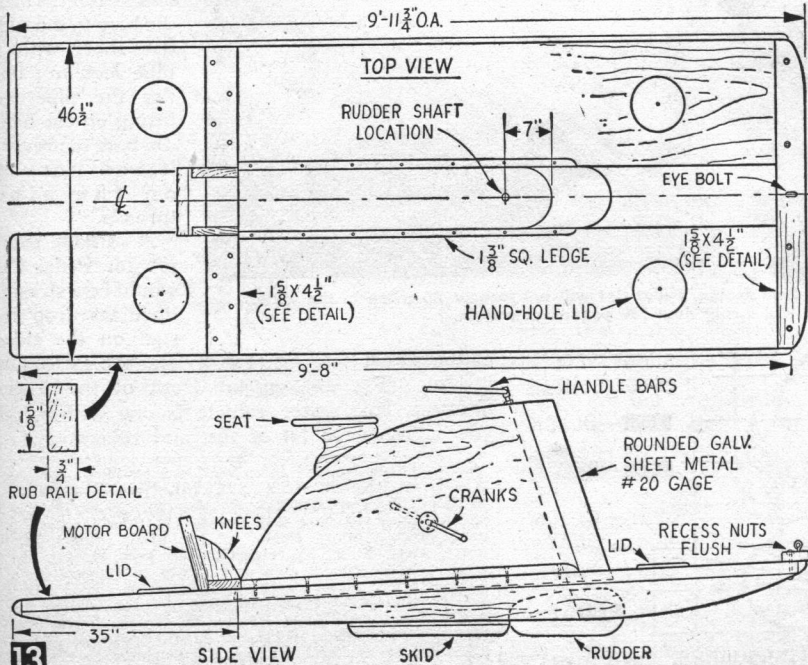

13

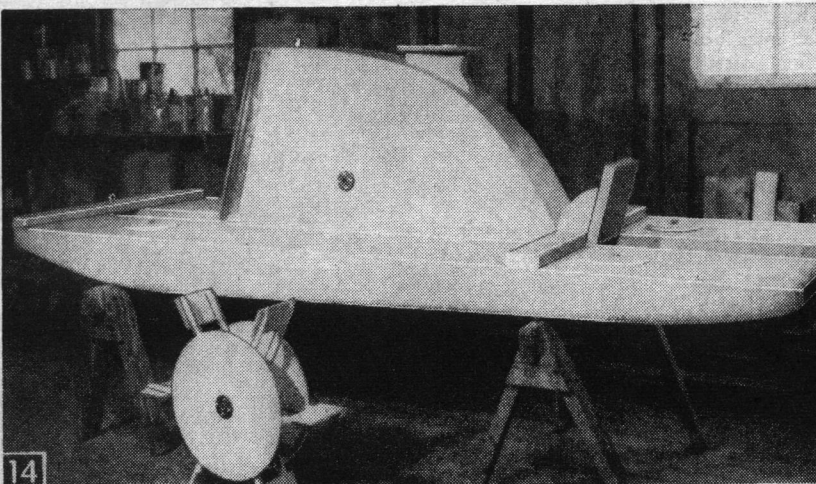

Completed boat with paddle wheel and handle bars removed.

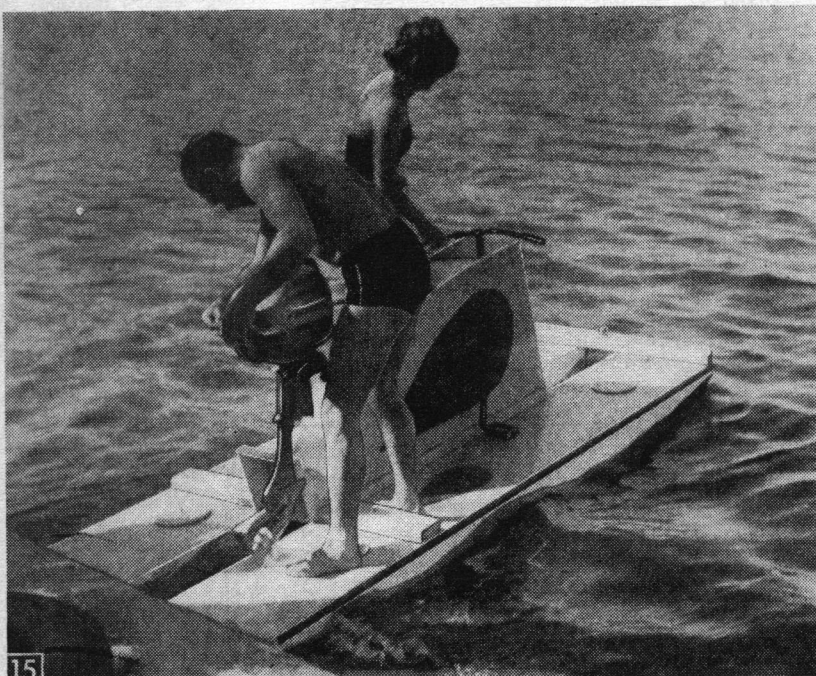

Because of its catamaran-type design, Pedal Cat will not rock or tip when in the water. It will easily float 700 pounds of weight.

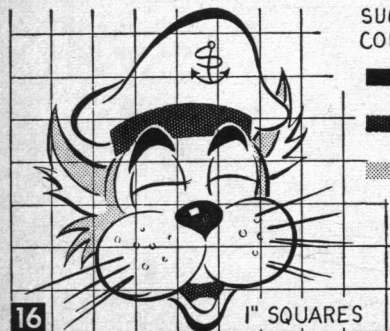

SUGGESTED
COLOR SCHEME

- — BLACK
- — RED
- — BLUE-GRAY

**PEDAL
CAT
INSIGNIA**

of the wheel housing (Fig. 3) and the Pedal Cat insignia (Fig. 16) on the front of the wheel housing. This water vehicle is one with which you will have a lot of fun and relaxation.

● Craft Print No. 221 in enlarged size for building Pedal Cat is available at \$1.50. SPECIAL QUANTITY DISCOUNT! If you order two or more craft prints (this or any other print), you may deduct 25¢ from the regular price of each print. Hence, for two prints, deduct 50¢; three prints, deduct 75¢, etc. Order by print number. To avoid possible loss of coin or currency in the mails, we suggest you remit by check or money order (no C.O.D.'s or stamps) to Craft Print Dept. B58, SCIENCE & MECHANICS, 450 East Ohio Street, Chicago 11, Illinois. See coupon on page 192. Now available, our new illustrated catalog of "186 Do It Yourself Plans," 10¢. Please allow three to four weeks for delivery.

on inside of pontoons.

Bolt the fore cross member flush with the pontoon nose pieces with washers and nuts on the outside and underneath the pontoons. Fasten a $\frac{1}{4}$ x 2-in. eyebolt through the center of the fore cross member for mooring your Pedal Cat. Attach the wheel housing to the pontoons with 2-in. #10 fh screws through holes previously drilled in the housing ledge pieces. Continue by bolting the four swinging lid holders (Fig. 4) to the pontoons and fasten the hand-hole lids to the holders with $\frac{1}{4}$ -in. fh bolts. Then replace the rudder and shaft and fasten the handle bars to the rudder shaft with a pipe lock nut under the pipe tee fitting on the handle bars to prevent it from loosening on the pipe threads.

A suitable paint job for Pedal Cat would be a streamlined teardrop design on the sides

